



Commercial
Vehicles

The Crafter Brochure

Volkswagen Commercial Vehicles' Van Centres. Working with you.

It's more than a van to you.

You're more than a customer to us.

We know that when you choose Volkswagen Commercial Vehicles, you're looking for more than just four walls on four wheels. You want a van that looks after itself while you take care of business. A vehicle that makes a statement, as well as a delivery. An investment for the future that makes a difference today.

To us, you're a partner.

By being there to get to know how you work and what you need, we can offer you more – supporting your plans year after year. It means a partnership that lasts as long as your ownership, with a vehicle and a team that's with you for the journey.

Our dedicated network of Van Centres.

Over **20 Dealerships** and **41 Authorised Repairers** means you're only around 45 minutes on average from our door.



Everything for the job... ...and the journey.

The right van.

We're commercial vehicle experts and finding the right van for your business is what makes us tick. We'll guide you through the range, take you on a test drive and cover all the options.

The right accessories.

From mudflaps to sat navs, plying to roof racks, we'll work with you to create the perfect van – keeping everything 100% Volkswagen to aid high residuals.

The right finance.

Every business is different, so we stay flexible, with a range of finance packages to choose from. Depending on your preference, we'll go through the options to find the one that suits you best.

The right support.

Nothing matters more than keeping you mobile, so our servicing options are built around you. You'll also enjoy three-years' free Roadside Assistance with your new van.

The right service.

We understand it's the little things that make the difference, so we set high standards. We'll call you when we say, keep you informed on delivery dates and support you long after purchase.

And there's more...

We offer a lot more than you might think. From cost-effective van rental or an air conditioning recharge, to a wide selection of premium and budget replacement tyres, if we're not able to help, we'll try and point you in the right direction!

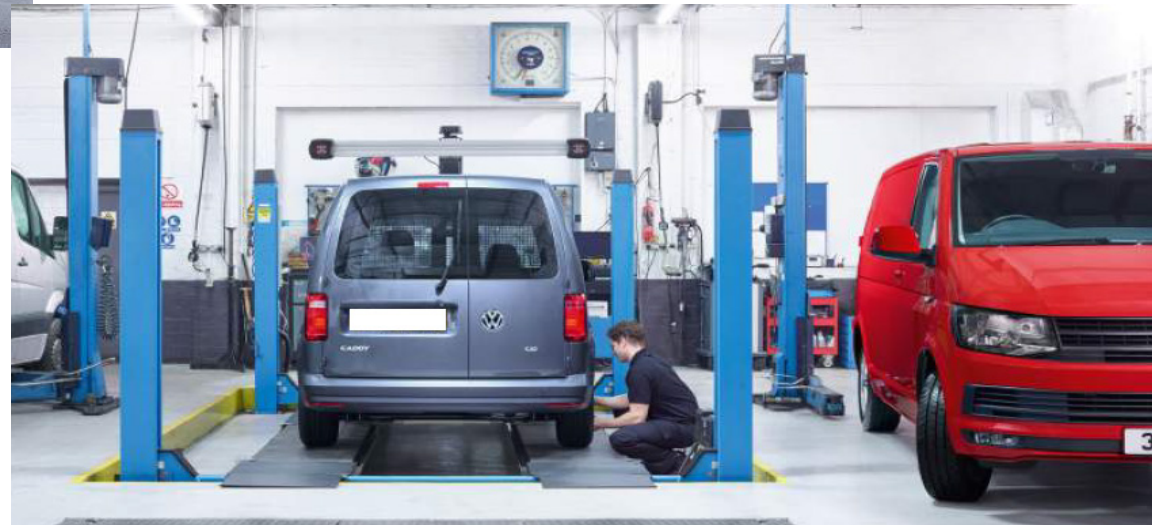

More practical, economical and innovative than ever before. The Crafter panel van is a commercial vehicle like no other. Designed by our customers for our customers. Built from the ground up, using 100% Volkswagen DNA as a cost-effective, transport-oriented solution to meet the demands of a diverse range of businesses. The Crafter panel van represents state-of-the-art manufacturing, with the sole aim of making it the best commercial vehicle in its class.

Crafted by you. Engineered by us.



Ready for the toughest jobs.

- Robust design, technologies and driver assistance systems.
- More practical, economical, and innovative than ever before.
- Outstanding in its class.



The perfect workplace.

- Available with an ergoComfort/ergoActive suspension seat*
- A variety of storage solutions with a wide range of different ports and connections
- Available with a heated leather multi-function steering wheel*
- Available with a 230V socket (300w)*

Excellent loadability.

- High load compartment of up to 2,196mm
- Wide side sliding door with an opening width of 1,311mm
- LED load compartment lighting*
- 100mm lower loading sill ²
- Up to 18.4m load volume ¹

A choice of drive systems.

- Front wheel drive delivers the highest possible load compartment
- The first van to offer an 8-speed automatic gearbox with a choice of front wheel, rear wheel and 4MOTION all-wheel drive

Value for money.

- High residual value
- Low fuel consumption
- Low maintenance costs

Superb connectivity.

- Telematics preparation including FMS 3.0 compatibility*
- Customer-specific function control unit (for special bodies and conversions)*
- Car-Net mobile online services*

Load securing options.

- Available with an optional universal floor*
- Load compartment designed for the addition of flexible shelving systems
- Interior roof rack*
- Up to 14 load-lashing rings

Numerous driver assistance and safety systems.

- The first with City Emergency Braking and Automatic Post-Collision Braking as standard
- Electromechanical Servotronic steering as standard
- Side protection*
- Lane Keeping Assist*
- Rear Traffic Alert*
- Trailer Assist*
- Park Assist*
- LED headlights*

* Available as an option. ¹ Will be introduced at a later date. ² Figure applies to the Crafter panel van with front wheel drive, compared to rear wheel drive and 4MOTION all-wheel drive. Illustration includes options at extra charge. Please contact your local Volkswagen Commercial Vehicles Van Centre for details of the standard equipment and optional extras available.

The perfect workplace.

Delivering storage, comfort and technology.



Storage and carrying compartments.

- Practical open storage compartments, consisting of three separate spaces
- Multiple sturdy cup holders
- Largest glovebox in its class
- Lower dashboard tray with space or longer items
- Storage in the doors for 1.5 litre bottles, folders and much more. Optional above-cab storage

Ports and connections.

- Standard USB port for charging mobile devices
- Standard Bluetooth® connection for mobile phones in conjunction with all radio and navigation devices
- Multiple 12V sockets. Optional 230V socket for charging tool batteries and laptops (not shown)

Comfort.

- Optional heated leather multi-function steering wheel
- Narrow 'A' pillars for improved all-round vision

The ergoComfort suspension seats. Adjustable for a more comfortable driving position.

The optional ergoComfort and ergoActive suspension seats with 20-way adjustment are designed to deliver optimum comfort through the reduction of road-related jolts. The combination of electric and manual adjustment allows the driver to select their preferred seating position. In addition, should you desire, the massage function is also available for the ergoActive suspension seat only.



The ergoComfort suspension seat.

- A Suspension seat with weight adjustment
- B Longitudinal seat adjustment
- C Seat height adjustment
- D Seat depth adjustment
- E Seat tilt adjustment
- F Backrest adjustment
- G Electric 4-way lumbar support
- H Headrest adjustment
- I Armrest adjustment

The ergoActive suspension seat.

- J Seat massage function*

* This feature is in addition to the standard features of the ergoComfort seat.

Two optional large storage compartments in the roof shelf.



A wide range of drive systems.

The Crafter panel van – available with an 8-speed automatic gearbox and a choice of three different drive systems.

The 8-speed automatic transmission is the only one in its class that can be combined with three different drive systems. It has been specially calibrated for the Crafter panel van's specific driving characteristics, enabling both comfortable and consumption-optimised handling.

Front wheel drive.



100mm lower load sill and entry height.
Highest load height in class.
Highest payload in the range.



Transversely-mounted front engine.



140HP engine

6-speed manual gearbox

8-speed automatic gearbox

177HP engine

6-speed manual gearbox

8-speed automatic gearbox

4MOTION
all-wheel drive.



Dependable traction and control.
Improved directional stability.



Transversely-mounted front engine.



140HP engine

6-speed manual gearbox

177HP engine

6-speed manual gearbox

8-speed automatic gearbox



State-of-the-art
driver assistance and safety systems.

Illustration includes options at extra charge.
Please contact your local Volkswagen Commercial Vehicles Centre for details of the standard equipment and optional extras available.

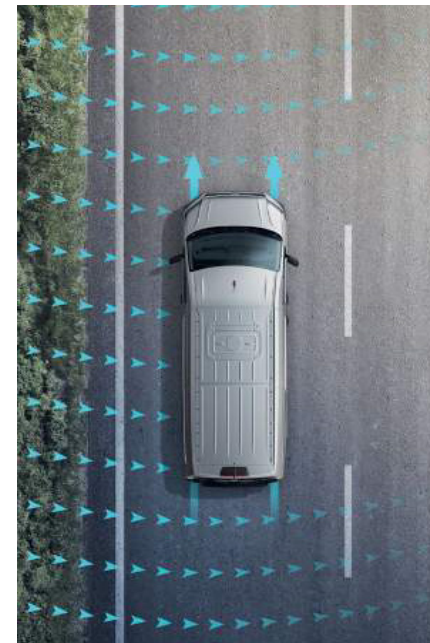

Crosswind Assist.

As part of the Electronic Stabilisation Programme (ESP), the standard Crosswind Assist applies adaptive braking intervention when the vehicle encounters a strong crosswind.



Front Assist with City Emergency Braking System.

this optional extra detects critical distances, warns of hazardous situations and when necessary, triggers emergency braking.



Images shown are for illustration purposes only and may not necessarily reflect Irish specification.

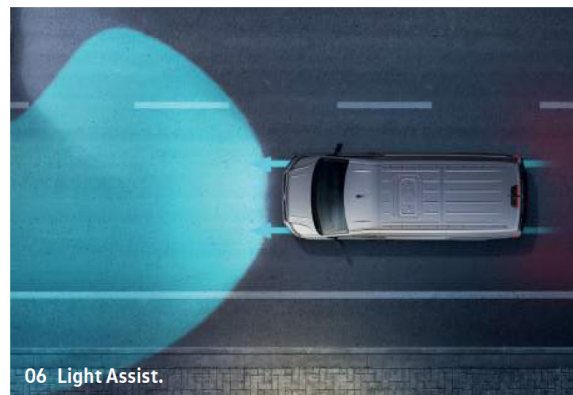
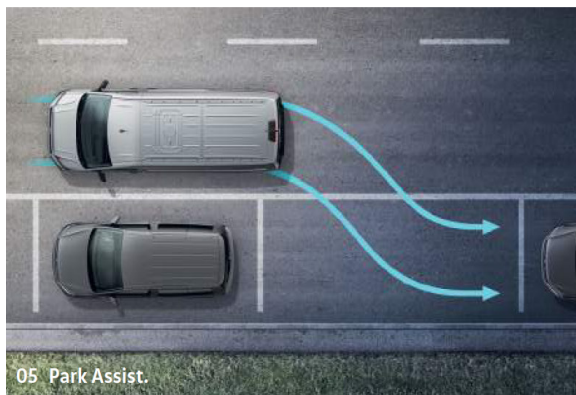
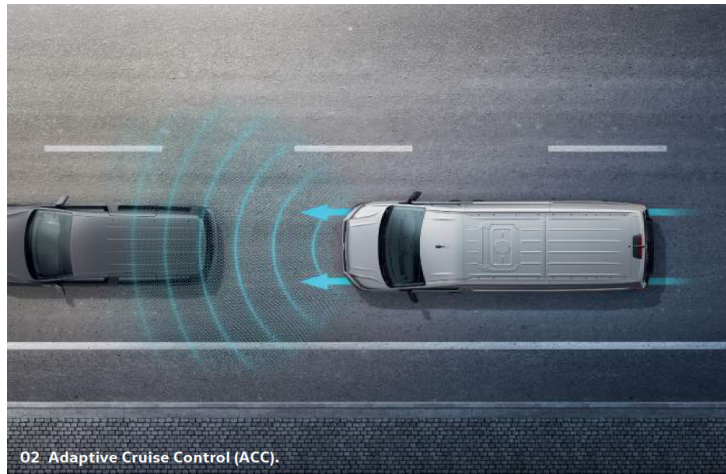
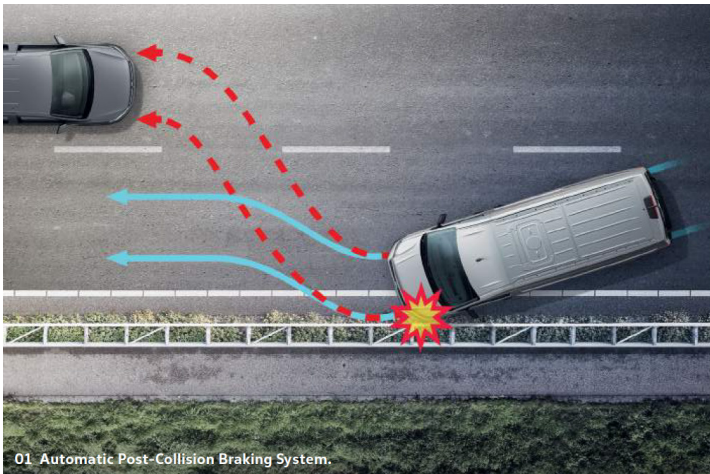

01 Automatic Post-Collision Braking System.
Fitted as standard, the Automatic Post-Collision Braking System triggers braking after a collision, with the aim of preventing secondary collisions.



02 Adaptive Cruise Control (ACC).
Optional ACC uses a front radar to measure the distance (up to 120 metres) and speed relative to vehicles driving ahead. It automatically regulates the pre-set distance. ACC also includes the Front Assist with City Emergency Braking System. This detects critical distances, warns of hazardous situations and when necessary, a speed of up to 18mph triggers emergency braking.



Side protection (not illustrated).

Available as an option, Side protection monitors the vehicle's sides and alerts you with visual and audible warnings if you're getting too close to other vehicles, pillars, walls or pedestrians.



03 Lane Keeping Assist.¹

Available as an option, Lane Keeping Assist countersteers the vehicle if the driver unintentionally drifts from a lane. The system also emits audible and visual warnings via the multi-function display to alert the driver of danger.



04 Rear Traffic Alert.

Available as an option, Rear Traffic Alert helps by emitting an audible warning when reversing out of a parking space if another vehicle is getting too close. If the driver fails to respond, the system intervenes and applies braking to help avoid a collision.



05 Park Assist.

This useful option aids positioning into parking spaces. When reverse is engaged, the vehicle assumes control of the steering. All that's required of the driver is to operate the accelerator and brake pedals, whilst keeping a good lookout.



06 Light Assist high-beam assistant.

This practical option automatically dips the headlights when it detects oncoming vehicles, or vehicles travelling ahead, to prevent other drivers from becoming dazzled. The system automatically switches on the high-beam headlights when the vehicle is travelling above 37mph in darkness.

¹ Within the system's thresholds. Please contact your local Volkswagen Commercial Vehicles Centre for details of the standard equipment and optional extras available.

Images shown are for illustration purposes only and may not necessarily reflect Irish specification.



Electromechanical Servotronic steering.
Fitted as standard, Electromechanical Servotronic steering provides a speed-sensitive operation with active return. This improves the steering feel around the mid-point, providing improved levels of steering precision.



Electronic Stabilisation Programme (ESP).
Fitted as standard, ESP is designed to prevent the vehicle from swerving in critical driving conditions by controlled and targeted intervention in the brakes and engine management system. This helps to maximise directional stability.



Rear-view camera. *
Simplifies parking by showing a limited view of the area behind the vehicle on the display of the radio or navigation system. Additional guidelines help the driver manoeuvre into the space. Optional on all models.



Cruise control.*
At 18mph and above, the system maintains your chosen preset speed through uphill and downhill inclines.



Tyre pressure monitoring system. 1*
Displays the current pressure for every tyre and warns of deviations from the set pressure. Optional on all models.



Driver Alert System.
Uses visual and audible warning signals to recommend that the driver takes a break as soon as it registers driving behaviour that indicates tiredness. Standard on all models.



Road Sign Display.*
Detects road signs and informs the driver about the current traffic situation. Optional on all models.



Fog lights with cornering function.*
Ensures optimum visibility in poor weather conditions and illuminates the roadside when turning.



Hill Descent Assist. 2
Allows you to descend slopes in a safe, controlled way by regulating the engine speed and applying the brakes as necessary.



Hill Start Assist.
This prevents the vehicle from rolling back on inclines, making it easier to start off on uphill slopes. Standard on all models.



Lane Change Assist - Side Scan. *
Side Scan displays a warning signal on the exterior mirror as soon as one of its sensors detects a vehicle in a blind spot during a lane change. Optional on all models.



Anti-lock braking system (ABS). 1
Prevents wheels from locking up and, thus, maintains manoeuvrability. Standard on all models.



Traction control system (ASR).
Prevents wheelspin on poor or unstable surfaces.



Driver's and front passenger's airbags.
Provides the best possible protection in the event of a frontal impact as a standard feature. Side airbags are also available as an option.



Seat belt warning.
If their seat belt is not fastened, the seat belt warning reminds the driver to fasten it with a visual warning when the engine is started, and an audible warning after setting off. Standard on all models.



Crafter

1 Within the system's thresholds. *optional extra (varies per trimline)

Illustration includes options at extra cost. Please contact your local Volkswagen Commercial VehiclesCentre for details of the standard equipment and optional extras available.

The Crafter panel van.

The Crafter panel van is distinguished by having even better loadability and load securing than ever before. The dimensions are ideal for transporting Euro pallets and roll containers. The factory-fitted preparation for shelves and cupboards, the optional universal floor and the optional internal roof rack combine to create even greater flexibility in the load compartment.

Highlights of the Crafter panel van

- Lowest aerodynamic drag in its class
- Largest load compartment height of up to 2,196mm¹
- Largest side loading and opening width of 1,311mm via the sliding door

1 Value applies to the Crafter panel van with long wheelbase Maxi, super-high roof and front-wheel drive.

2 In comparison to rear-wheel drive and 4MOTION all-wheel drive.

Illustration includes options at extra charge. Please contact your local Volkswagen Commercial Vehicles Van Centre for details of the standard equipment and optional extras available.





01 Rear wing doors. The two roof-height doors provide an opening angle of 180°. On Trendline models the standard rear wing doors are extended to an increased opening of 270°. The 270° rear wing doors are available as an option on Startline models.

02 Wooden floor.² This 8mm thick wooden floor for the load compartment provides the optimum surface for your cargo to rest on. Robust beechwood ensures outstanding sturdiness and resilience. Standard on Trendline and Highline (optional on Startline models.)

03 Universal floor.^{1,2} This wooden floor is the ideal basis for retrofitting the shelving and cupboard systems available from a range of manufacturers. Special adapters enable cupboard systems to be easily fastened using the notches. Longitudinal and transverse load-lashing rails are available as an option for the universal floor.

Storage pockets for the rear wing doors (not shown).¹ The removable storage pockets provide a safe and handy storage option for small tools.

Protective grilles for the rear wing doors (not shown).¹ These protect the rear windows against glass breakage and also help to prevent theft.

Up to 14 load-lashing rings (not shown). The Crafter panel van features two additional load-lashing rings on the partition allowing you to securely fasten cargo with tensioning straps and nets. The adjustable load-lashing rings are recessed to lie flush with the floor. To reduce the risk of being a trip hazard, they can also be folded to the sides in the vicinity of the doors.

Preparation for shelving systems (not shown). There are numerous holes for M6 bolts above and below the window area that simplify installation. The holes are spaced 100mm intervals.

Innovative load compartments

- Preparation for shelving systems
- Available with a sturdy, hard-wearing beechwood floor
Standard on Trendline and optional on Startline models
- Up to 14 high-strength, retractable load-lashing rings



¹ Optional at extra cost. ² Will be introduced at a later date.

Illustration includes options at extra charge. Please contact your local Volkswagen Commercial Vehicles Van Centre for details of the standard equipment and optional extras available.



01 Bulkhead – full-height without window. A roof compartment above the driver's cabin is available upon request for the high roof variant and is a standard feature with the super-high roof.

02 Half-height plywood side lining.¹ The load compartment cladding made of 5mm thick rigid plywood panels is especially robust. It is fitted from the floor up to the load-lashing rails and is also highly durable.

03 Storage boxes above the wheel housings.¹ Fitted above both wheel housings in the load compartment and provide space for tools, high visibility vests, gloves, etc.

04 Roof-height plywood side lining.¹ 5mm thick rigid plywood panels make this side cladding especially resistant to impacts and is also highly durable.

05 Load-lashing rails.¹ Robust metal rails are available for the side walls, the bulkhead, the roof frame and universal floor for optimum load securing.

Solutions for partitioning, securing and working

- Optional internal roof rack for long objects
- Also available with optional load-lashing rails on the side walls, partitions and also on the roof



06 Internal roof rack.¹ Enables easy transport of long objects. The two rails can be moved within the vehicle and adjusted to the length of the objects. They can also be removed when the roof rack is not needed.

230V socket, external and internal (not shown).¹ The 230V external CEE socket provides the interior of the vehicle with an electricity supply of up to 2500W (16A) via a socket in the load compartment. This enables electrical equipment to be used inside the vehicle. The scope of delivery also includes a circuit breaker and a charger for the vehicle battery.

07 LED load compartment lighting.¹ Four LEDs integrated into the headlining provide bright and evenly distributed illumination of the load compartment.

12V sockets (not shown).¹ A 12V socket is integrated into an accessible location on the D-pillar of the rear wing door and on the sliding door.

¹ Optional at extra cost.

Illustration includes options at extra charge. Please contact your local Volkswagen Commercial Vehicles Van Centre for details of the standard equipment and optional extras available.

Easy to load. Loads of space.



Side sliding door with 1,311mm opening width. Easy to load and unload with common load carriers such as Euro pallets.

High load compartment with up to 2,196mm.¹ In conjunction with front wheel drive, the Crafter panel van offers a competitive load height for its class.

100mm lower load sill. Compared to the rear wheel drive and 4MOTION all-wheel drive, the front wheel drive further simplifies loading and unloading thanks to its lower load sill.

Universal floor for fitting third-party storage systems.⁵

The optional wooden floor is the ideal base for fitting your choice of storage system from a range of manufacturers. Special adapters for the notches in the floor deliver the flexibility to add or remove items with ease.

Preparation for shelving systems. Numerous hexagonal holes for M6 screw fittings are located every 100mm within the load area, simplifying the mounting of shelves and storage units.

Wheel Base	Medium	Long	Maxi
Load Dimensions	Length: 3,450mm Width: 1,832mm	Length: 4,300mm Width: 1,832mm	Length: 4,855mm Width: 1,832mm
Load Volume	9.9m ² -11.3m ²	14.4m ² -16.1m ²	16.4m ² -18.4m ²

¹Not available with a low roof. ³ Not available in conjunction with a super-high roof. ² Optional at extra cost.

Illustration includes options at extra charge. Please contact your local Volkswagen Commercial Vehicles Van Centre for details of the standard equipment and optional extras available.

Audio & Communication.



01 Radio 'Composition Audio'

Fitted as standard on the Startline, the Composition Audio radio system features a thin film transistor LCD screen, two USB (type-C) ports, Bluetooth®, SD card slot and four speakers delivering 20 watt output.



02 Radio 'Composition Colour'

Fitted as standard on the Trendline (optional on Startline), the Composition Colour DAB+ radio system features a 6.5 inch TFT touch-screen colour display, two USB (type-C) ports, Bluetooth®, SD card slot and four speakers delivering 20 watt output. It also features App-Connect, an integrated eSIM and mobile online services as part of We Connect and We Connect Plus.



03 Radio 'Ready 2 Discover'

Fitted as standard on the Highline (optional on Startline & Trendline), the 'Ready 2 Discover' radio system features a 8 inch TFT touch-screen colour display, four speakers delivering 20 watt output and Navigation system preparation. It also features wired & wireless App-Connect, an integrated eSIM and mobile online services as part of We Connect and We Connect Plus.



04 Navigation system 'Discover Media'

The Optional 'Discover Media' satellite navigation system features an 8 inch colour touch-screen with proximity sensor. The system also includes a 32GB media storage, natural voice control, free map updates via the internet and mobile online services with Volkswagen We Connect Plus, App-Connect and integrated eSIM.

We Connect¹ and We Connect Plus^{1,2}

With Volkswagen We Connect¹ driving will now be even more digital, closely integrated and comfortable. A wide range of services gives you quick access to the California 6.1 – conveniently via your smartphone. The heart of the system is the We Connect¹ App. It connects your smartphone to the vehicle with an integrated eSIM card. The standard We Connect¹ package includes various vehicle reports, useful tools for service planning and a breakdown call. Also included: the parking position finder, which guides you directly to the vehicle. You can add many other services with the We Connect Plus^{1,2} package. For example, using your smartphone, the online anti-theft warning system immediately sends a message to the mobile phone in the event of burglary attempts, and thanks to online map updates, the map material is always up to date. To take advantage of these exclusive services, you can register today with the We Connect¹ Portal. Once your vehicle has been activated, you can access the full range of Mobile Online Services.

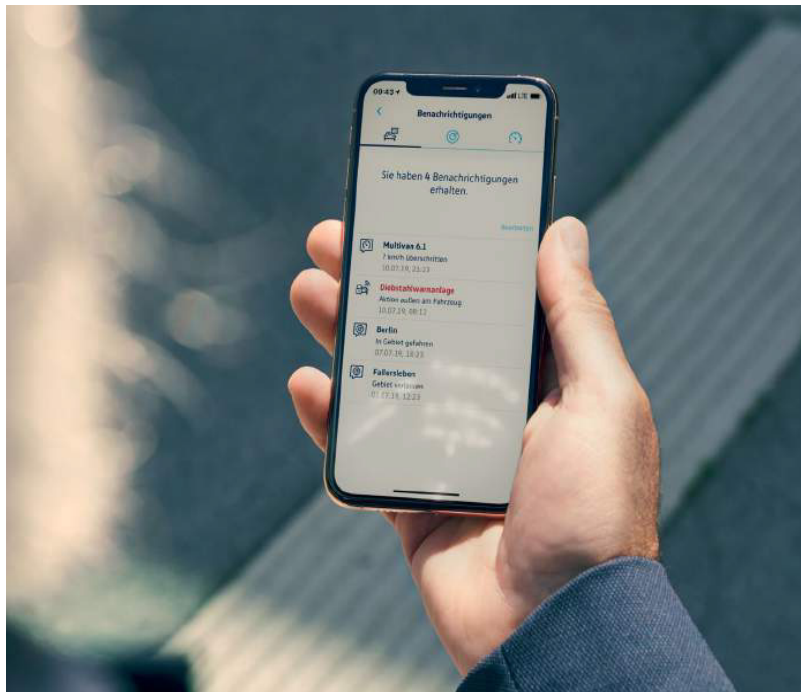

We Connect¹

Breakdown call

Information call

Parking Position

Automatic Accident Notification

Vehicle status

Doors & Lights

Vehicle Health Report

Driving Data

Service Scheduling



We Connect Plus^{1,2}

Online Traffic Information⁷

Online POI search

Online Map Update

Online Voice Control

Media Streaming⁶

Area Alert

Online anti-theft warning system³

Lock & Unlock⁴

Speed Alert

Horn & Turn Signals

Online Route Calculation

Filling Stations

Parking Spaces

¹ To use We Connect services, you need a Volkswagen ID user account and must log in to We Connect with your user name and password. A separate We Connect contract or We Connect Plus contract will also need to be made online with Volkswagen AG. For We Connect Plus you have 90 days after the handover of the vehicle to register the vehicle on www.portal.volkswagen-we.com and can use services free during this time. ² Free of charge for the first year when you order Composition Colour or Discover Media navigation system. There is an extra charge in the event of renewal once the free period has expired. ³ Only in combination with the anti theft alarm system. Standard on Highline models, optional on Startline models. ⁴ The Lock & Unlock service is a security feature and requires a prior identity check by means of the Volkswagen ID procedure. This involves your identity being checked by a Volkswagen dealer or via video chat. ⁵ Available from April 2020. ⁶ Only available in conjunction with the Discover Media navigation system and Streaming & Internet package. Optional at extra cost. The scope of services of We Connect and We Connect Plus may vary and can be used at a later date. ⁷ Only in conjunction with the Discover Media navigation systems. Optional at extra cost.

Crafter panel van Startline

Standard Equipment

Exterior

- Cab doors with power windows
- Exhaust tailpipe extruding at vehicle center
- Fuel tank filter secured by locking passenger door
- Towing eye front and rear
- Rear wing doors
- Side marker lights on Long & Maxi models
- Left sliding door in load compartment
- Side wind compensation
- 75-litre lockable fuel tank

Cab Area

- "Austin" cloth upholstery
- Heat insulated windshield made of laminated glass
- Convenient storage compartments
- Interior lighting in passenger compartment
- Internal steps in passenger compartment
- Bulkhead without window
- Rubber floor covering in cab
- Drivers seat with reach and rake adjustments
- Dual passenger seat with storage
- Electric front windows
- 12v sockets x2
- Two reading lights

Audio & Communications

- Mobile phone interface
- "Composition Audio" - Bluetooth
- Radio FM/AM

Safety & Security

- Anti-lock Braking System (ABS)
- Brake assist
- Electronic Brake-Force Distributions (EBD)
- Electronic Differential Lock (EDL)
- Electronic stabilisation programme (ESP)
- Height-adjustable head restraints
- Hill start assist
- Remote Central Locking with interior locking

Cargo Area

- Interior entry step
- Lashing rings for load compartments
- Rear door interior release lever
- Steel flooring
- Door activated interior lights



1 Images shown may contain additional charged optional extras

Crafter panel van Trendline

Standard Equipment

Cab Area

Comfort driver seat 'Plus' with armrests, height adjustment, tilt adjustment and 4 way electric lumbar support

Heated windscreen

PDC Front & Rear

Storage Package with overhead storage, 2 X 1-DIN slots and reading light

Cruise control

Multi-function steering wheel

Cargo Area

Grab handles on rear pillars

Audio & Communications

App-Connect

Radio 'Composition Colour' 6.5" Touch Screen

Exterior

Rear wing doors 270 degree opening

16" Steel Wheels

Front fog lamps with cornering function



Crafter panel van Highline

Standard Equipment

Cab Area

Heated Leather-wrapped multi-function steering wheel

Climatic Air Conditioning System

Radio 'Ready 2 Discover' 8" touch screen

Driver Assistance

Rearview Camera

Cargo Area

Load Compartment Lighting: 4 X LED Spotlights



1 Images shown may contain additional charged optional extras

2 The above specifications are for information purposes only as our products are continually updated and changes may be made to the specifications at any time. If you require any specific feature, you must consult your local dealer who is regularly updated with any change in specification. Specifications are subject to change without notice.

Paint & upholstery

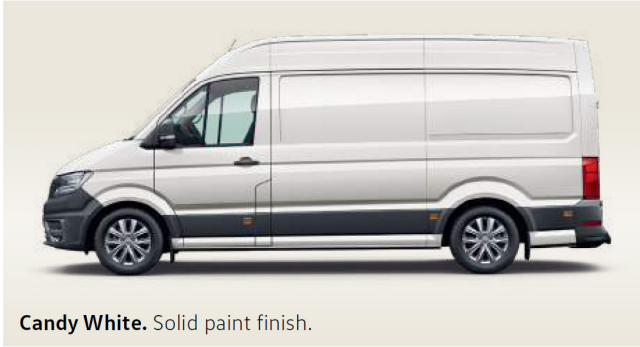

Candy White. Solid paint finish.



Cherry Red. Solid paint finish.



Bright Orange. Solid paint finish.

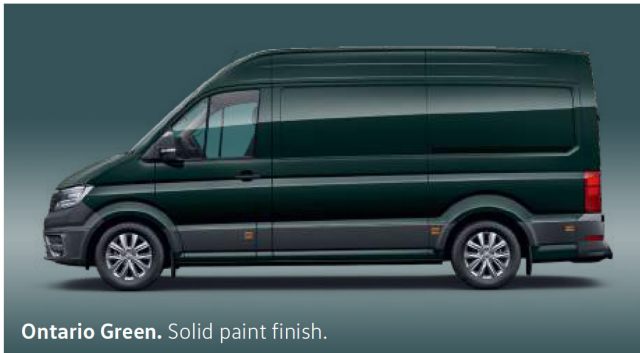

Ontario Green. Solid paint finish.

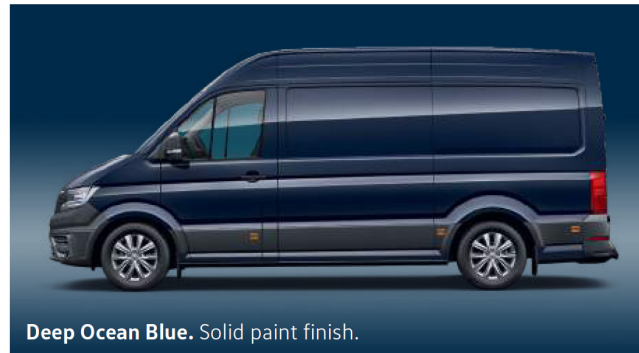

Deep Ocean Blue. Solid paint finish.

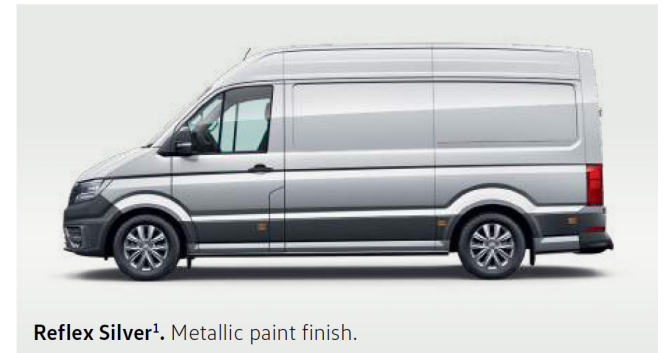

Reflex Silver¹. Metallic paint finish.



Indium Grey¹. Metallic paint finish.



Deep Black¹. Pearl Effect paint finish.

¹ Charged optional extra

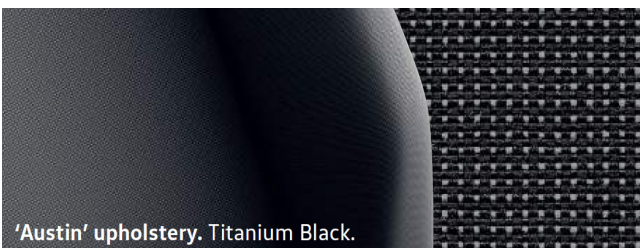

'Austin' upholstery. Titanium Black.

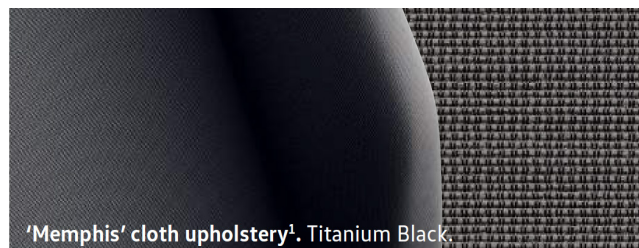

'Memphis' cloth upholstery¹. Titanium Black

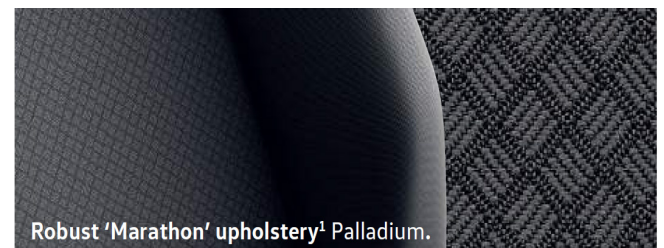

Robust 'Marathon' upholstery¹ Palladium.

Engine & gearbox data

Engine specifications	2.0 TDI 140HP	2.0 TDI 177HP
Mixture preparation/injection method	Common-rail/exhaust-gas turbocharger	Common-rail/exhaust-gas turbocharger
EU exhaust emission standard	6d-TEMP-EVAP-ISC	6d-TEMP-EVAP-ISC
Number of cylinders	4	4
Cubic capacity	1,968cc	1,968cc
Output, HP at rpm	140 at 3,500-3,600	177 at 3,600
Torque, max. Nm at rpm	340 at 1,600-2,250	410 at 1,500-2,000
Fuel tank capacity	75 litres	75 litres
AdBlue® tank capacity	18 litres	18 litres
Diesel Particulate Filter [DPF]	●	●
6-speed manual gearbox	●	●
8-speed automatic gearbox	○	○
Front-wheel drive	●	●
Rear-wheel drive	○	○
4MOTION	○	○
Alternator	180 A	180 A
Battery	95 Ah	95 Ah

Panel van technical data & weights

Model	Engine	Engine (cc)	No. Doors	No. Seats	Co2 (g)	Gross Vehicle Weight (Kg)	Payload (Kg)	Unladen Weight (Kg)	Trailer mass braked/unbraked	Axel weight front (Kg)	Axel weight rear (Kg)
Crafter 30 MWB 140HP M6F	103	1968	5	3	202	3000	1012	2063	3000 / 750	1800	2100
Crafter 35 MWB 140HP M6F	103	1968	5	3	202	3500	1587	1988	3000 / 750	1800	2100
Crafter 35 MWB 140HP A8F	103	1968	5	3	194	3500	1529	2046	3000 / 750	1800	2100
Crafter 35 MWB 140HP M6A	103	1968	5	3	240	3500	1435	2140	3000 / 750	1800	2100
Crafter 35 MWB 177HP M6F	130	1968	5	3	206	3500	1577	1998	3000 / 750	1800	2100
Crafter 35 MWB 177HP A8F	130	1968	5	3	251	3500	1375	2200	3000 / 750	1800	2100
Crafter 35 MWB 177HP M6A	130	1968	5	3	236	3500	1459	2116	3000 / 750	1800	2100
Crafter 35 MWB 177HP A8A	130	1968	5	3	245	3500	1394	2181	3000 / 750	1800	2100
Crafter 35 LWB 140HP M6F	103	1968	5	3	205	3500	1456	2119	3000 / 750	1800	2100
Crafter 35 LWB 140HP A8F	103	1968	5	3	202	3500	1424	2151	3000 / 750	1800	2100
Crafter 35 LWB 177HP M6F	130	1968	5	3	210	3500	1447	2128	3000 / 750	1800	2100
Crafter 35 LWB 177HP A8F	130	1968	5	3	251	3500	1200	2375	3000 / 750	1800	2100
CRAFTER 35 ELW 140HP M6F	103	1968	5	3	205	3500	1376	2199	3500 / 750	1800	2100
CRAFTER 35 ELW 177HP M6F	130	1968	5	3	210	3500	1367	2208	3500 / 750	1800	2100

Please Note: additional weight categories and variations are available upon request for fleet orders. Please contact your local Volkswagen Commercial Van Centre for more information in our range of products.

Panel van dimensions

CR30/35 medium wheelbase

Roof height		Low ¹	High ¹
Wheelbase		3,640	3,640
Load compartment	length, mm	3,450/3,201**	3,450/3,201**
	width, mm	1,832	1,832
	width between wheel arches, mm	1,380	1,380
	height, mm (FWD/RWD & 4MOTION)	1,726/1,626	1,961/1,861
	load volume, m ³ (FWD/RWD & 4MOTION)	9.9/9.3	10.7/9.3
Side sliding door	width, mm	1,311	1,311
	height, mm	1,587	1,722
Rear wing doors	width, mm	1,552	1,552
	height, mm	1,605	1,740
Turning circle (wall to wall), m		13.6	13.6

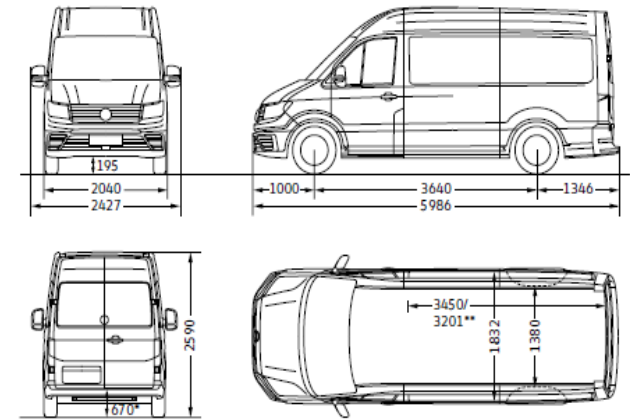

Illustration shown is CR35 medium wheelbase panel van with high roof.
^{*} This value applies for RWD & 4MOTION all-wheel drive.
^{**} Load compartment length, max. (at floor level)/load compartment length, min.

All dimensions in millimetres (mm), unless otherwise stated.

¹ CR30 and CR35: RWD & 4MOTION derivatives have a lower internal load height due to a raised floor (by 100mm).

CR35 long wheelbase

Roof height		High ¹ (standard)	Super-high ¹ (optional)
Wheelbase		4,490	4,490
Load compartment	length, mm	4,300/4,051**	4,300/4,051**
	width, mm	1,832	1,832
	width between wheel arches, mm	1,380	1,380
	height, mm (FWD/RWD & 4MOTION)	1,961/1,861	2,189/2,089
	load volume, m ³ (FWD/RWD & 4MOTION)	14.4/13.6	16.1/15.3
Side sliding door	width, mm	1,311	1,311
	height, mm	1,822	1,822
Rear wing doors	width, mm	1,552	1,552
	height, mm	1,840	1,840
Turning circle (wall to wall), m		16.2	16.2

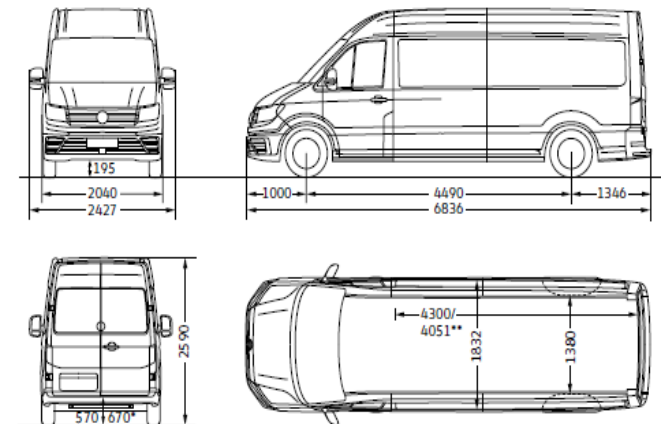

Illustration shown is CR35 long wheelbase panel van with high roof.
^{*} On high roof models, this value applies for RWD & 4MOTION all-wheel drive and rear-wheel drive.
^{*} On super-high roof models, this value applies for RWD & 4MOTION all-wheel drive only.
^{**} Load compartment length, max. (at floor level)/load compartment length, min.

All dimensions in millimetres (mm), unless otherwise stated.

¹ CR35: RWD & 4MOTION derivatives have a lower internal load height due to a raised floor (by 100mm).

Please note: all measurements listed are based on series vehicles. The loading sill and height dimensions listed here may vary by approximately ±50 mm depending on the equipment fitted and load. The vehicle drawings are not to scale.

Panel van dimensions

CR35 long wheelbase Maxi

Roof height		High ¹ (standard)	Super-high ¹ (optional)
Wheelbase		4,490	4,490
Load compartment	length, mm	4,855/4,606**	4,855/4,606**
	width, mm	1,832	1,832
	width between wheel arches, mm	1,380	1,380
	height, mm (FWD/RWD & 4MOTION)	1,961/1,861	2,196/2,096
	load volume, m ³ (FWD/RWD & 4MOTION)	16.4/15.5	18.4/17.5
Side sliding door	width, mm	1,311	1,311
	height, mm	1,822	1,822
Rear wing doors	width, mm	1,552	1,552
	height, mm	1,840	1,840
Turning circle (wall to wall), m		16.2	16.2

All dimensions in millimetres (mm), unless otherwise stated.

¹ CR35: RWD & 4MOTION derivatives have a lower internal load height due to a raised floor (by 100mm).

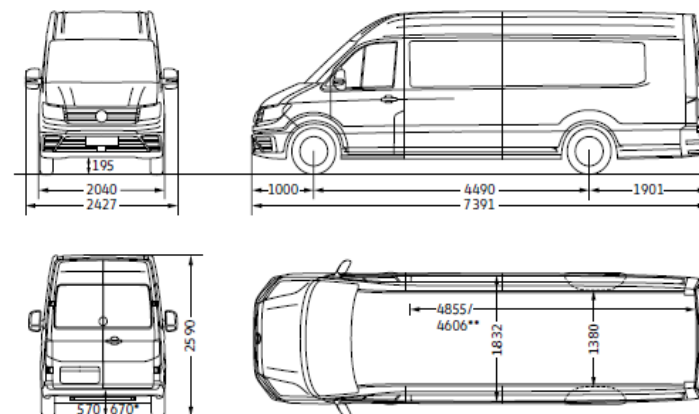

Illustration shown is CR35 long wheelbase Maxi with high roof.

* This value applies for RWD & 4MOTION all-wheel drive.

**Load compartment length, max. (at floor level)/load compartment length, min.

Panel van pricelist

Startline

Medium Wheel Base

Model Code	Engine / Transmission	GVW(KG)	RRP* (ex VAT)	VRT	VAT	RRP (incl. VAT)	ROTR* (Incl Delivery)
SYBA4A	2.0 TDI 140hp 6-speed manual	3000	€ 28,032.92	€ 200.00	€ 6,447.08	€ 34,680.00	€ 35,630.00
SYBB4A	2.0 TDI 140hp 6-speed manul	3500	€ 29,792.97	€ 200.00	€ 6,852.03	€ 36,845.00	€ 37,795.00
SYBB4B	2.0 TDI 140hp 8-speed automatic	3500	€ 31,747.65	€ 200.00	€ 7,302.35	€ 39,250.00	€ 40,200.00
SYBB4Y	2.0 TDI 140hp 6-speed manual 4M	3500	€ 33,357.32	€ 200.00	€ 7,672.68	€ 41,230.00	€ 42,180.00
SYBB8A	2.0 TDI 177hp 6-speed manual	3500	€ 31,520.71	€ 200.00	€ 7,249.29	€ 38,970.00	€ 39,920.00
SYBB8B	2.0TDI 177HP 8 - speed automatic	3500	€ 33,467.06	€ 200.00	€ 7,697.94	€ 41,365.00	€ 42,315.00
SYBB8Y	2.0 TDI 177hp 6-speed manual 4M	3500	€ 35,081.00	€ 200.00	€ 8,069.00	€ 43,350.00	€ 44,300.00
SYBB8Z	2.0 TDI 177hp 8-speed automatic 4M	3500	€ 37,020.30	€ 200.00	€ 8,514.70	€ 45,735.00	€ 46,685.00

Long Wheel Base

Model Code	Engine / Transmission	GVW(KG)	RRP* (ex VAT)	VRT	VAT	RRP (incl. VAT)	ROTR* (Incl Delivery)
SYCB4A	2.0 TDI 140hp 6-speed manual	3500	€ 32,577.04	€ 200.00	€ 7,492.96	€ 40,270.00	€ 41,220.00
SYCB4B	2.0 TDI 140hp 8-speed automatic	3500	€ 34,552.86	€ 200.00	€ 7,947.14	€ 42,700.00	€ 43,650.00
SYCB8A	2.0 TDI 177hp 6-speed manual	3500	€ 34,231.97	€ 200.00	€ 7,873.03	€ 42,305.00	€ 43,255.00
SYCB8B	2.0TDI 177HP 8 - speed automatic	3500	€ 35,842.58	€ 200.00	€ 8,242.42	€ 44,285.00	€ 45,235.00

Extra Long Wheel Base

Model Code	Engine / Transmission	GVW(KG)	RRP* (ex VAT)	VRT	VAT	RRP (incl. VAT)	ROTR* (Incl Delivery)
SYDB4A	2.0 TDI 140hp 6-speed manual	3500	€ 33,585.29	€ 200.00	€ 7,724.71	€ 41,510.00	€ 42,460.00
SYDB8A	2.0 TDI 177hp 6-speed manual	3500	€ 35,630.38	€ 200.00	€ 8,194.62	€ 44,025.00	€ 44,975.00

Panel van pricelist

Trendline

Medium Wheel Base

Model Code	Engine / Transmission	GVW(KG)	RRP* (ex VAT)	VRT	VAT	RRP (incl. VAT)	ROTR* (Incl Delivery)
SYBA4A	2.0 TDI 140hp 6-speed manual	3000	€ 29,805.24	€ 200.00	€ 6,854.76	€ 36,860.00	€ 37,810.00
SYBB4A	2.0 TDI 140hp 6-speed manual	3500	€ 31,784.43	€ 200.00	€ 7,310.57	€ 39,295.00	€ 40,245.00
SYBB4B	2.0 TDI 140hp 8-speed automatic	3500	€ 33,723.57	€ 200.00	€ 7,756.43	€ 41,680.00	€ 42,630.00
SYBB4Y	2.0 TDI 140hp 6-speed manual 4M	3500	€ 35,345.94	€ 200.00	€ 8,129.06	€ 43,675.00	€ 44,625.00
SYBB8A	2.0 TDI 177hp 6-speed manual	3500	€ 33,508.55	€ 200.00	€ 7,706.45	€ 41,415.00	€ 42,365.00
SYBB8B	2.0 TDI 177HP 8 - speed automatic	3500	€ 35,382.46	€ 200.00	€ 8,137.54	€ 43,720.00	€ 44,670.00
SYBB8Y	2.0 TDI 177hp 6-speed manual 4M	3500	€ 37,073.33	€ 200.00	€ 8,526.67	€ 45,800.00	€ 46,750.00
SYBB8Z	2.0 TDI 177hp 8-speed automatic 4M	3500	€ 39,012.23	€ 200.00	€ 8,972.77	€ 48,185.00	€ 49,135.00

Long Wheel Base

Model Code	Engine / Transmission	GVW(KG)	RRP* (ex VAT)	VRT	VAT	RRP (incl. VAT)	ROTR* (Incl Delivery)
SYCB4A	2.0 TDI 140hp 6-speed manual	3500	€ 34,593.05	€ 200.00	€ 7,956.95	€ 42,750.00	€ 43,700.00
SYCB4B	2.0 TDI 140hp 8-speed automatic	3500	€ 36,564.72	€ 200.00	€ 8,410.28	€ 45,175.00	€ 46,125.00
SYCB8A	2.0 TDI 177hp 6-speed manual	3500	€ 36,247.92	€ 200.00	€ 8,337.08	€ 44,785.00	€ 45,735.00
SYCB8B	2.0 TDI 177HP 8 - speed automatic	3500	€ 38,138.23	€ 200.00	€ 8,771.77	€ 47,110.00	€ 48,060.00

Extra Long Wheel Base

Model Code	Engine / Transmission	GVW(KG)	RRP* (ex VAT)	VRT	VAT	RRP (incl. VAT)	ROTR* (Incl Delivery)
SYDB4A	2.0 TDI 140hp 6-speed manual	3500	€ 35,175.01	€ 200.00	€ 8,089.99	€ 43,465.00	€ 44,415.00
SYDB8A	2.0 TDI 177hp 6-speed manual	3500	€ 37,223.88	€ 200.00	€ 8,561.12	€ 45,985.00	€ 46,935.00

Please Note: additional weight categories and variations are available upon request for fleet orders. Please contact your local Volkswagen Commercial Van Centre for more information in our range of products.

Panel van pricelist

Highline

Medium Wheel Base

Model Code	Engine / Transmission	GVW(KG)	RRP* (ex VAT)	VRT	VAT	RRP (incl. VAT)	ROTR* (Incl Delivery)
SYBA4A	2.0 TDI 140hp 6-speed manual	3000	€ 31,804.85	€ 200.00	€ 7,315.15	€ 39,320.00	€ 40,270.00
SYBB4A	2.0 TDI 140hp 6-speed manual	3500	€ 33,772.04	€ 200.00	€ 7,767.96	€ 41,740.00	€ 42,690.00
SYBB4B	2.0 TDI 140hp 8-speed automatic	3500	€ 35,723.54	€ 200.00	€ 8,216.46	€ 44,140.00	€ 45,090.00
SYBB4Y	2.0 TDI 140hp 6-speed manual 4M	3500	€ 37,337.50	€ 200.00	€ 8,587.50	€ 46,125.00	€ 47,075.00
SYBB8A	2.0 TDI 177hp 6-speed manual	3500	€ 35,495.66	€ 200.00	€ 8,164.34	€ 43,860.00	€ 44,810.00
SYBB8B	2.0 TDI 177HP 8 - speed automatic	3500	€ 37,227.83	€ 200.00	€ 8,562.17	€ 45,990.00	€ 46,940.00
SYBB8Y	2.0 TDI 177hp 6-speed manual 4M	3500	€ 39,068.67	€ 200.00	€ 8,986.33	€ 48,255.00	€ 49,205.00
SYBB8Z	2.0 TDI 177hp 8-speed automatic 4M	3500	€ 41,004.19	€ 200.00	€ 9,430.81	€ 50,635.00	€ 51,585.00

Long Wheel Base

Model Code	Engine / Transmission	GVW(KG)	RRP* (ex VAT)	VRT	VAT	RRP (incl. VAT)	ROTR* (Incl Delivery)
SYCB4A	2.0 TDI 140hp 6-speed manual	3500	€ 36,593.85	€ 200.00	€ 8,416.15	€ 45,210.00	€ 46,160.00
SYCB4B	2.0 TDI 140hp 8-speed automatic	3500	€ 38,569.31	€ 200.00	€ 8,870.69	€ 47,640.00	€ 48,590.00
SYCB8A	2.0 TDI 177hp 6-speed manual	3500	€ 38,247.79	€ 200.00	€ 8,797.21	€ 47,245.00	€ 48,195.00
SYCB8B	2.0 TDI 177HP 8 - speed automatic	3500	€ 39,971.21	€ 200.00	€ 9,193.79	€ 49,365.00	€ 50,315.00

Extra Long Wheel Base

Model Code	Engine / Transmission	GVW(KG)	RRP* (ex VAT)	VRT	VAT	RRP (incl. VAT)	ROTR* (Incl Delivery)
SYDB4A	2.0 TDI 140hp 6-speed manual	3500	€ 37,179.14	€ 200.00	€ 8,550.86	€ 45,930.00	€ 46,880.00
SYDB8A	2.0 TDI 177hp 6-speed manual	3500	€ 39,223.13	€ 200.00	€ 9,021.87	€ 48,445.00	€ 49,395.00

The Crafter

This brochure supersedes all previous publications.

Issue: 01 October 2021

www.volkswagenvans.ie

Please note: Screen technology does not allow exact reproduction of the paint and upholstery colours. Some of the vehicles shown are European specification and may be fitted with optional equipment or accessories that are available at extra cost, or do not reflect current specification. All data and specifications are in accordance with information available at the time of publication and are subject to change without notice. Vehicles not currently in Irish stock and customer order vehicles may take a number of weeks for delivery. Certain combinations of vehicle specifications and factory-fitted options are not compatible and therefore all orders received are subject to confirmation. Models, factory fitted-options and paint and upholstery options are subject to availability. Please check details and availability with an authorised Volkswagen Van Centre at the time of ordering.